





Apparecchio da incassare a soffitto. Fornito con cornice in alluminio con staffe per fissaggio. Filtri in vetro colorato a richiesta per una illuminazione ad effetto.

Ceiling recessed. Aluminium trim with adjustable bracket for mounting. Accessories available include colour filters upon request for lighting effects.



CERTIFICAZIONI CERTIFICATION	 
GRADO DI PROTEZIONE IP / IK RATING	IP 66 / IK 07 IP 66 / IK 07
CLASSE DI ISOLAMENTO CLASSIFICATION	classe I  class I
CORPO BODY	alluminio pressofuso EN AB 44100 alta resistenza all'ossidazione die-cast aluminium EN AB 44100 high resistance to oxidation
FISSAGGIO MOUNTING	anello in alluminio con staffe regolabili per fissaggio a controsoffitto aluminium ring with adjustable bracket for false ceiling
DIFFUSORE DIFFUSER	vetro sodico calcico temprato 5 mm soda-lime tempered glass 5 mm
VITERIA ESTERNA EXTERNAL FIXINGS	inox A4-70 trattata in soluzione lubrificante idrorepellente con alto potere antiossidante. Il trattamento assicura la facile apertura del prodotto durante la manutenzione. stainless steel A4-70 treated with highly antioxidant water-repellent lubricating solution. The treatment ensures easy opening of the product for maintenance
GUARNIZIONI SEALING GASKET	Silicone ricotto silicone
ENTRATA CAVO CABLE ENTRY	entrata doppia con passacavi in silicone Ø 10/14mm double by silicone bushing Ø 10/14mm
LAMPADINA LAMP	esclusa not included
FINITURA FINISH	verniciatura in polveri poliestere ad alta resistenza ai raggi UV ed alla corrosione powder coating polyester high resistance to UV and oxidation

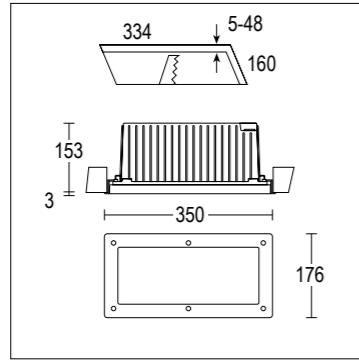

IP66 codice colori
colour codes
— .01 bianco
white

IK07

5620.95F.A.01 26 W TC-DE G24q-3 1800 lm
220-240 V 50/60 HZ
vetro acidato *acid etched diffuser*
alimentatore elettronico incluso
electronic ballast integral

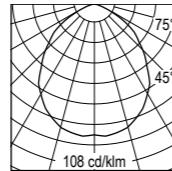
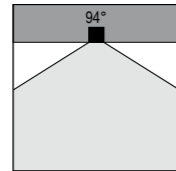

H (m)	Ø (m)	lux med.	lux max.
1	2.13	21	192
2	4.26	5	48
3	6.39	2	21
4	8.52	1	12
5	10.65	1	8

5620.77T.A.01 2 x 26 W TC-D G24d-3 3600 lm
230 V 50 HZ
vetro acidato *acid etched diffuser*
alimentatore ferromagnetico incluso
conventional ballast integral

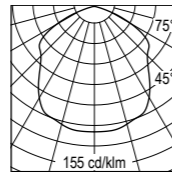
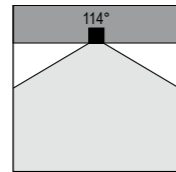

H (m)	Ø (m)	lux med.	lux max.
1	3.08	45	557
2	6.16	11	139
3	9.24	5	62
4	12.32	3	35
5	15.40	2	22

