







Proiettore da incasso a terreno orientabile sull'asse verticale sino a 90°. Corpo in pressofusione di alluminio lega EN AB 44100 , verniciato a polvere poliestere con primer epossidico di fondo, processo nano-tech, telaio in acciaio inox AISI 316L. Cassaforma in ferro trattato con cataforesi da ordinare a parte, si raccomanda l'installazione con 300 mm di drenaggio.



Ground recessed projector adjustable up to 90° on the vertical axis. Body in powder coated die cast aluminum EN AB 44100 with protective undercoating, nano-tech process. AISI 316L stainless steel trim. Treated aluminum Rough in Housing sold separately. 300mm of drainage recommended.

CERTIFICAZIONI CERTIFICATION	 
	versioni led disponibili: 3000 K / 4000 K LEDs available: 3000 K / 4000 K
GRADO DI PROTEZIONE IP / IK RATING	IP 67 / IK 09 IP 67 / IK 09
CLASSE DI ISOLAMENTO CLASSIFICATION	classe I 
CORPO BODY	alluminio pressofuso EN AB 44100 alta resistenza all'ossidazione die-cast aluminium EN AB 44100 high resistance to oxidation
CONTROCASSA ROUGH-IN HOUSING	ferro con trattamento in cataforesi nera (inclusa) da ordinare separatamente iron with black cathoretic treatment (included) to be ordered separately
DIFFUSORE DIFFUSER	vetro sodico calcico temprato 15 mm soda-lime tempered glass 15 mm
RIFLETTORE REFLECTOR	versione HIT / TC-DE - alluminio con deposizione in alto vuoto di alluminio purissimo 99,99% versione Led - termoplastica con deposizione in alto vuoto ad alte efficienza Led Version - high efficiency termoplastic, with high vacuum deposit HIT / TC-DE version - 99.99% pure aluminium high vacuum deposit
VITERIA ESTERNA EXTERNAL FIXINGS	inox A4-70 trattata in soluzione lubrificante idrorepellente con alto potere antiossidante. il trattamento assicura la facile apertura del prodotto durante la manutenzione stainless steel A4-70 treated with highly antioxidant water-repellent lubricating solution. the treatment ensures easy opening of the product for maintenance
GUARNIZIONI SEALING GASKET	silicone ricotto silicone
CABLAGGIO WIRING	apparecchio fornito con 0,5 m di cavo H07RN8-F pre cablato con pressacavo in ottone PG 13,5 resinato fixture supplied with pre wired cable 0.5 m long H07RN8-F with brass cable gland PG 13.5 resin sealed
SECONDO CAVO SECOND CABLE	disponibile su richiesta available upon request
ORIENTABILITA' POSITIONING	orientabilità sull'asse verticale (75°) con possibilità di bloccaggio del puntamento mechanical system allows fixture locking and adjustment on vertical (75°) axe
DRENAGGIO DRAINAGE AREA	300 mm 300 mm
LAMPADINA LAMP	esclusa (Led incluso) not included (Led integral)
FINITURA FINISH	verniciatura in polveri poliestere ad alta resistenza ai raggi UV ed alla corrosione powder coating polyester high resistance to UV and oxidation

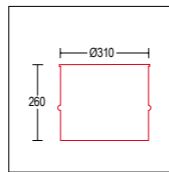
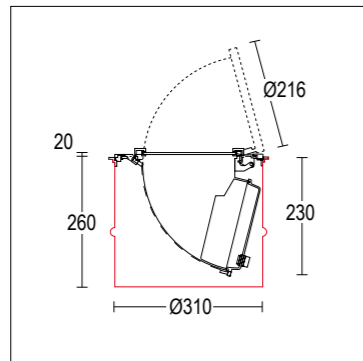

codice controcassa
rough-in housing code
150.--

codice colori
colour codes
 .05 grigio antracite
anthracite grey
 .13 grigio chiaro
light grey

5200.ECS.T-- 32 W 1 Led 3000 K 3312 lm
5200.EDS.T-- 32 W 1 Led 4000 K 3460 lm
 220-240 V 50/60 HZ
 vetro trasparente *clear diffuser*
 alimentatore incluso *led driver integral*

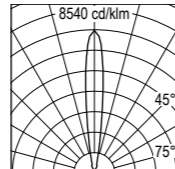
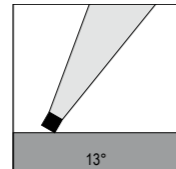

H (m)	Ø (m)	lux med. 3000 K	lux max. 3000 K	lux med. 4000 K	lux max. 4000 K
5	1.17	550	1097	592	1182
4	0.94	859	1714	926	1847
3	0.70	1528	3048	1646	3283
2	0.47	3437	6858	3703	7387
1	0.23	13749	27430	14811	29548

5200.ECM.T-- 32 W 1 Led 3000 K 3312 lm
5200.EDM.T-- 32 W 1 Led 4000 K 3460 lm
 220-240 V 50/60 HZ
 vetro trasparente *clear diffuser*
 alimentatore incluso *led driver integral*

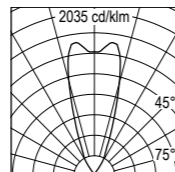
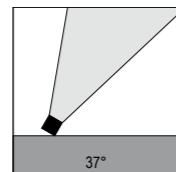

H (m)	Ø (m)	lux med. 3000 K	lux max. 3000 K	lux med. 4000 K	lux max. 4000 K
5	3.37	115	248	120	259
4	2.69	180	387	188	404
3	2.02	230	688	334	719
2	1.35	719	1548	751	1618
1	0.67	2876	6193	3004	6470

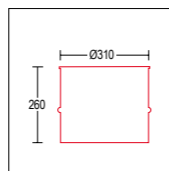
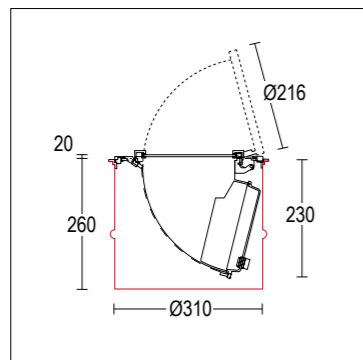

codice controcassa
rough-in housing code
150.--

codice colori
colour codes
 .05 grigio antracite
anthracite grey
 .13 grigio chiaro
light grey

5200.17M.T-- 35 W HIT G12 3300 lm
 230 V 50 HZ
 vetro trasparente *clear diffuser*
 alimentatore ferromagnetico incluso
conventional ballast integral

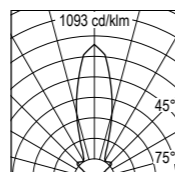
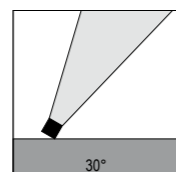

H (m)	Ø (m)	lux med.	lux max.
5	2.75	65	144
4	2.20	102	225
3	1.65	181	401
2	1.10	406	901
1	0.55	1626	3606

5200.19M.T-- 70 W HIT G12 6600 lm
 230 V 50 HZ
 vetro trasparente *clear diffuser*
 alimentatore ferromagnetico incluso
conventional ballast integral

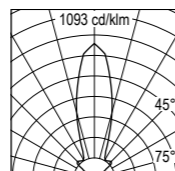
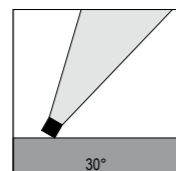

H (m)	Ø (m)	lux med.	lux max.
5	2.75	130	288
4	2.20	203	451
3	1.65	361	801
2	1.10	813	1803
1	0.55	3251	7211

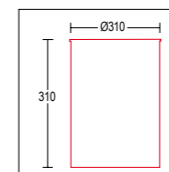
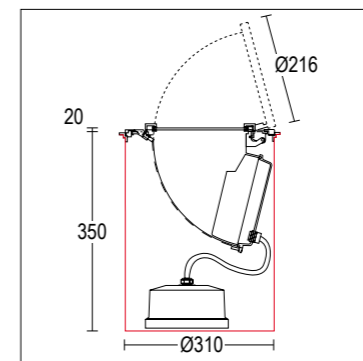

codice controcassa
rough-in housing code
151.--

codice colori
colour codes
 .05 grigio antracite
anthracite grey
 .13 grigio chiaro
light grey

5201.21M.T-- 150 W HIT G12 14000 lm
 230 V 50 HZ
 vetro trasparente *clear diffuser*
 alimentatore ferromagnetico incluso
conventional ballast integral

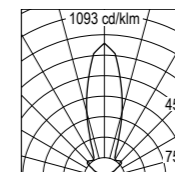
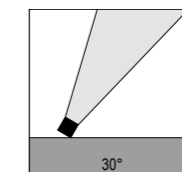

H (m)	Ø (m)	lux med.	lux max.
5	2.75	276	612
4	2.20	431	956
3	1.65	766	1700
2	1.10	1724	3824
1	0.55	6896	15296

Accessori Accessories



276
 Connettore rapido IP 68
IP 68 fast connector

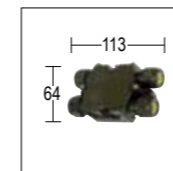

279
 Connettore per cablaggio in cascata IP 68
IP 68 connector for through wiring



714 grigio antracite *anthracite grey*
715 grigio chiaro *light grey*
 Visiera in ferro
Steel clow

