

Plafoniera a parete realizzata in alluminio pressofuso e copertura in acciaio Inox Aisi 316L. Caratterizzata da un design moderno e forme pure e lineari. La copertura è disponibile in varie configurazioni.

Wall mounted fixture made of die-cast aluminum with AISI 316L stainless steel cover. Characterised by a modern design with a pure linear shape. The cover is available in different configurations.

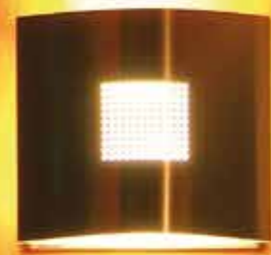

CERTIFICAZIONI
CERTIFICATION



versioni led disponibili: 3000 K / 4000 K
LEDs available: 3000 K / 4000 K

GRADO DI PROTEZIONE
IP / IK RATING

IP 65 / IK 07
IP 65 / IK 07

CLASSE DI ISOLAMENTO
CLASSIFICATION

classe I
class I

CORPO
BODY

alluminio pressofuso EN AB 44100 alta resistenza all'ossidazione
die-cast aluminium EN AB 44100 high resistance to oxidation

DIFFUSORE
DIFFUSER

policarbonato opale resistente all'urto e ai raggi UV
vandal proof opal polycarbonate UV resistant

VITERIA ESTERNA
EXTERNAL FIXINGS

inox A4-70 trattata in soluzione lubrificante idrorepellente con alto potere antiossidante. Il trattamento assicura la facile apertura del prodotto durante la manutenzione.
stainless steel A4-70 treated with highly antioxidant water-repellent lubricating solution. The treatment ensures easy opening of the product for maintenance

GUARNIZIONI
SEALING GASKET

silicone ricotto
silicone

APERTURA
OPENING

a cerniera
by hinge

ENTRATA CAVO
CABLE ENTRY

passacavo in silicone Ø10/14 mm
silicone bushing Ø10/14 mm

LAMPADINA
LAMP

esclusa
not included

Manta

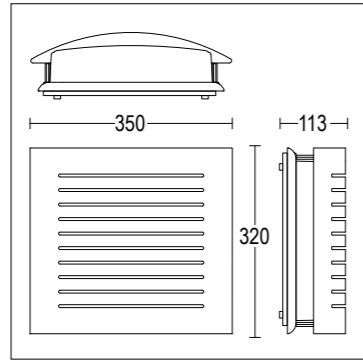
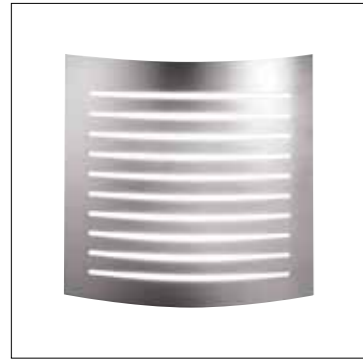

IP65 codice colori
colour codes

.15 acciaio inox
stainless steel

IK07

⚡

⚠ Disponibile su richiesta versione in emergenza
Emergency version available upon request

1710.BRX.O.15 13 W Led 3000 K 1670 lm

1710.BSX.O.15 13 W Led 4000 K 1730 lm

220-240 V 50/60 HZ
vetro trasparente *clear diffuser*
alimentatore incluso *led driver integral*

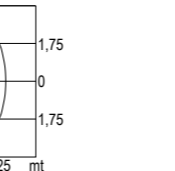
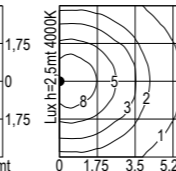
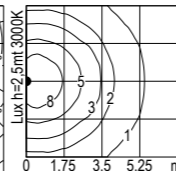
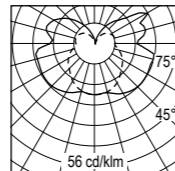
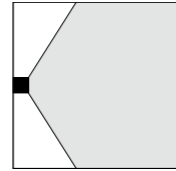

1710.75F.O.15 2x18 W TC-D G24d-2 2x1200 lm

230 V 50 HZ
policarbonato opale *opal polycarbonate*
alimentatore ferromagnetico incluso
conventional ballast integral

