

codice controcassa
rough-in housing code
017

codice colori
colour codes
.15 acciaio inox
stainless steel

5329.CGA.T.15 26 W 1 Led 3000 K 2668 lm
5329.CHA.T.15 26 W 1 Led 4000 K 2787 lm
220-240 V 50/60 HZ
vetro trasparente *clear diffuser*
alimentatore incluso *led driver integral*

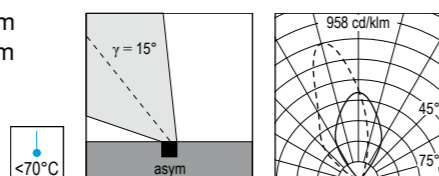

5329.CGM.T.15 26 W 1 Led 3000 K 2689 lm
5329.CHM.T.15 26 W 1 Led 4000 K 2810 lm
220-240 V 50/60 HZ
vetro trasparente *clear diffuser*
alimentatore incluso *led driver integral*

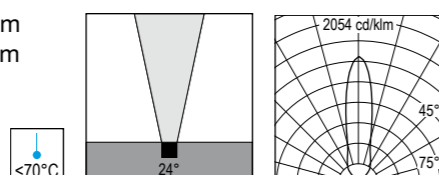

H (m)	Ø (m)	lux med. 3000 K	lux max. 3000 K	lux med. 4000 K	lux max. 4000 K
5	2.11	104	221	108	231
4	1.69	162	345	169	361
3	1.26	288	614	301	641
2	0.84	648	1380	677	1443
1	0.42	2591	5522	2708	5770

5329.CGF.T.15 26 W 1 Led 3000 K 2689 lm
5329.CHF.T.15 26 W 1 Led 4000 K 2810 lm
220-240 V 50/60 HZ
vetro trasparente *clear diffuser*
alimentatore incluso *led driver integral*

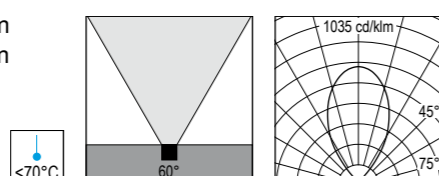

H (m)	Ø (m)	lux med. 3000 K	lux max. 3000 K	lux med. 4000 K	lux max. 4000 K
5	5.80	36	111	38	116
4	4.64	57	174	59	182
3	3.48	101	309	105	323
2	2.32	226	696	237	727
1	1.16	905	2783	946	2909

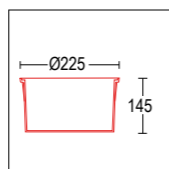
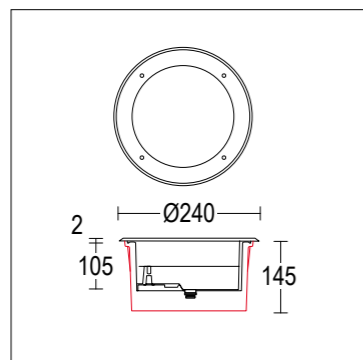

codice controcassa
rough-in housing code
017

codice colori
colour codes
.15 acciaio inox
stainless steel

5329.FAP.T.15 15 W 4 Led 3000 K 2132 lm
5329.FBP.T.15 15 W 4 Led 4000 K 2356 lm
220-240 V 50/60 HZ
vetro trasparente *clear diffuser*
alimentatore incluso *led driver integral*
orientabile *adjustable* 10°

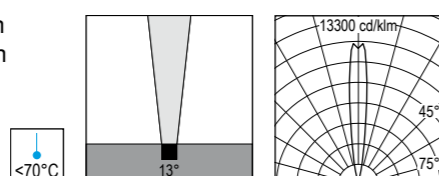

H (m)	Ø (m)	lux med. 3000 K	lux max. 3000 K	lux med. 4000 K	lux max. 4000 K
5	1.16	581	1134	643	1253
4	0.93	909	1772	1004	1958
3	0.69	1615	3151	1785	3482
2	0.46	3634	7089	4016	7834
1	0.23	14536	28356	16063	31335

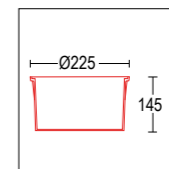
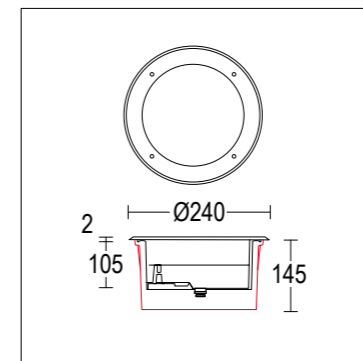

codice controcassa
rough-in housing code
017

codice colori
colour codes
.15 acciaio inox
stainless steel

5329.P3E.T.15 12 W 4 Led RGB 420 lm
max 350 mA DC
vetro trasparente *clear diffuser*
alimentatore remoto SELV non incluso
remote SELV led driver not included
orientabile *adjustable* 10°

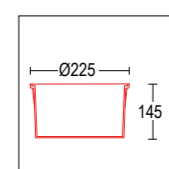
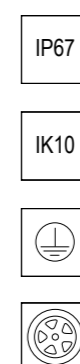
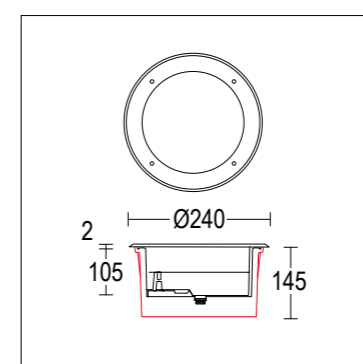
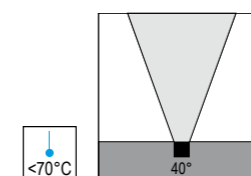

codice controcassa
rough-in housing code
017

codice colori
colour codes
.15 acciaio inox
stainless steel

5329.92F.A.15 26W TC-T Gx24q-3 1800 lm
220-240 V 50/60 HZ
vetro acidato *acid etched diffuser*
alimentatore elettronico incluso
electronic ballast integral

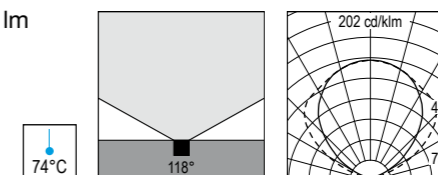

H (m)	Ø (m)	lux med.	lux max.
5	16.71	1	15
4	13.37	2	23
3	10.03	3	40
2	6.68	6	91
1	3.34	25	364

5329.80F.A.15 26W TC-T Gx24d-3 1800 lm
220-240 V 50/60 HZ
vetro acidato *acid etched diffuser*
alimentatore ferromagnetico incluso
conventional ballast integral

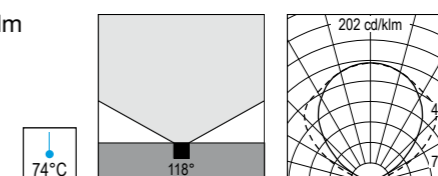

H (m)	Ø (m)	lux med.	lux max.
5	16.71	1	15
4	13.37	2	23
3	10.03	3	40
2	6.68	6	91
1	3.34	25	364

5329.36F.A.15 57 W INC E27
220-240 V 50/60 HZ
vetro acidato *acid etched diffuser*

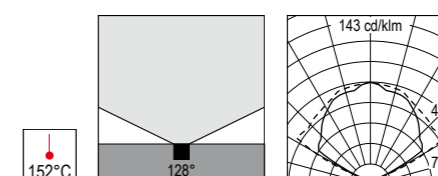

H (m)	Ø (m)	lux med.	lux max.
5	21.74	4	71
4	17.39	6	111
3	13.04	10	197
2	8.70	23	443
1	4.35	94	1773

Accessori Spiacar Spiacar accessories



105
Vetro anti-scivolo
fattore R12 DIN 51130
anti-slip glass
factor R12 DIN 51130

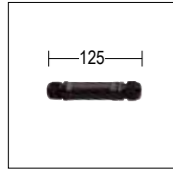

276
Connettore rapido IP 68
IP 68 fast connector

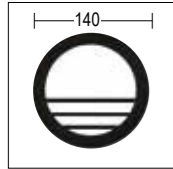

158
Schermo anti-abbagliamento
Solo per la versione 1 Led simmetrica
Vouvre screen anti glare
only for 1 Led symmetrical version

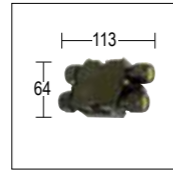

279
Connettore per cablaggio in cascata IP 68
IP 68 connector for through wiring

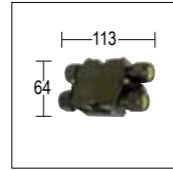

278
Connettore per cablaggio in cascata RGB IP 68
IP 68 RGB connector for through wiring

Accessori RGB RGB accessories



627
Alimentatore 350 mA
1 alimentatore per 1-2 Spiacar RGB
Led driver 350 mA
1 local power source for 1-2 Spiacar RGB

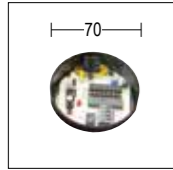

628
Convertitore
1 convertitore per 10 alimentatori 627
Converter
1 Converter for 10 led drivers 627

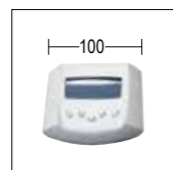

626
Generatore DMX
1 generatore per 6 convertitori
DMX generator
1 generator for 6 converters

Schema di collegamento RGB
RGB scheme

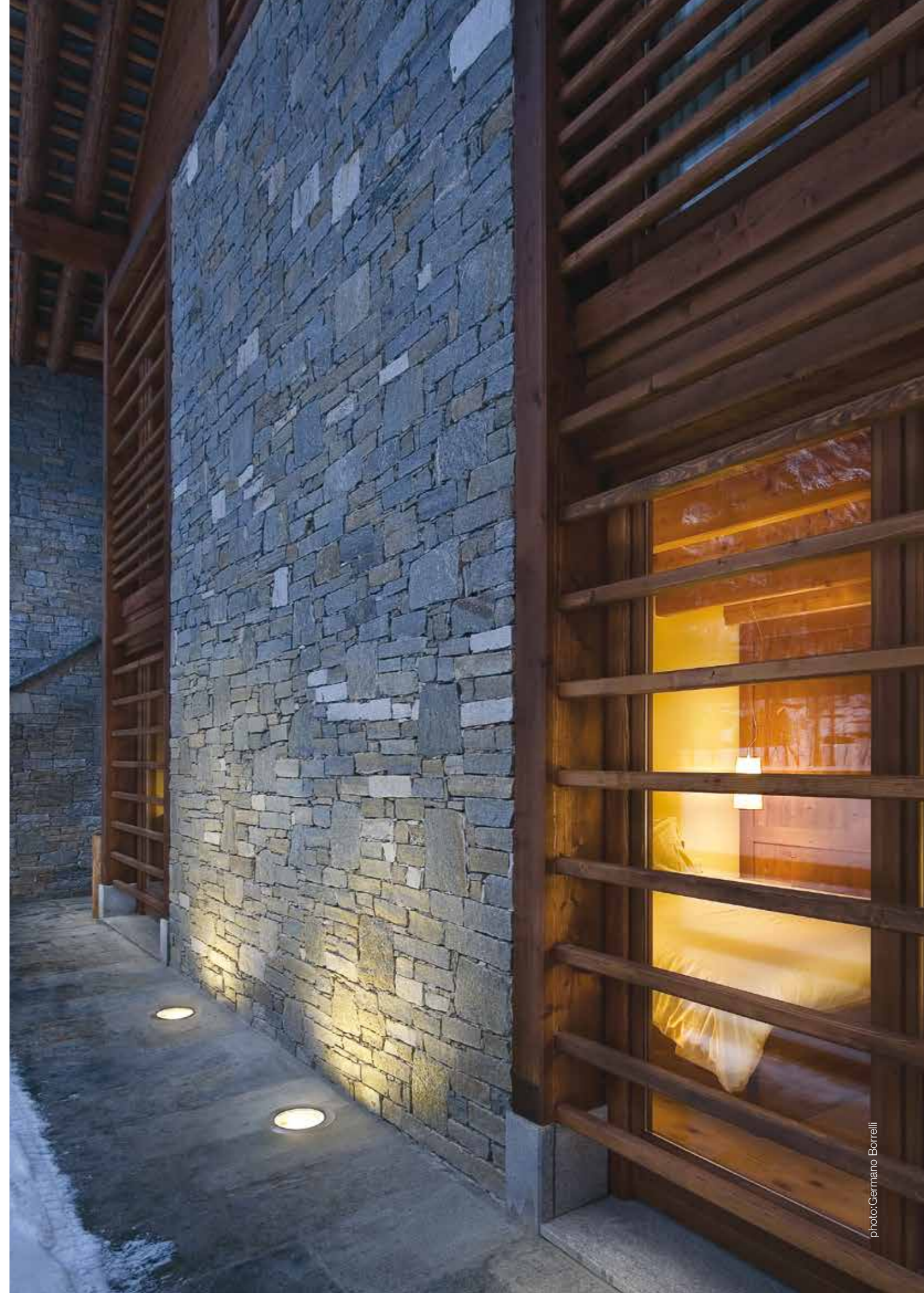
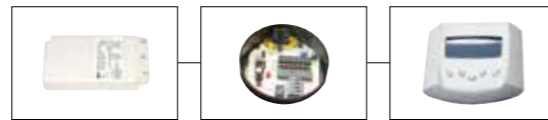

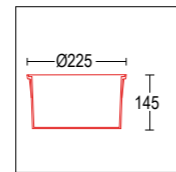
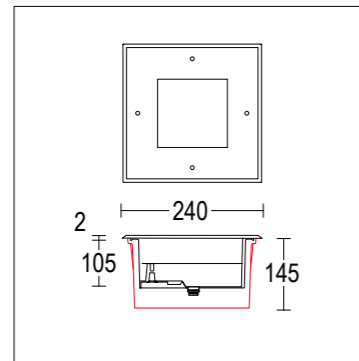
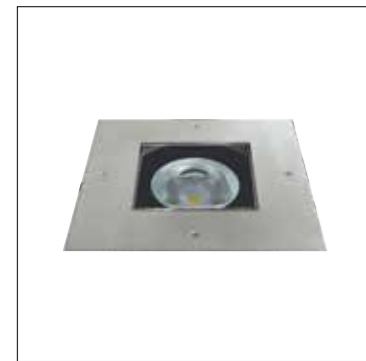

codice controcassa
rough-in housing code
017

codice colori
colour codes
.15 acciaio inox
stainless steel

5323.CGA.T.15 26 W 1 Led 3000 K 2668 lm
5323.CHA.T.15 26 W 1 Led 4000 K 2787 lm
220-240 V 50/60 HZ
vetro trasparente *clear diffuser*
alimentatore incluso *led driver integral*

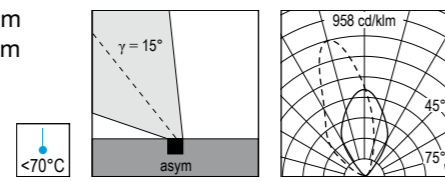

<70°C

5323.CGM.T.15 26 W 1 Led 3000 K 2689 lm
5323.CHM.T.15 26 W 1 Led 4000 K 2810 lm
220-240 V 50/60 HZ
vetro trasparente *clear diffuser*
alimentatore incluso *led driver integral*

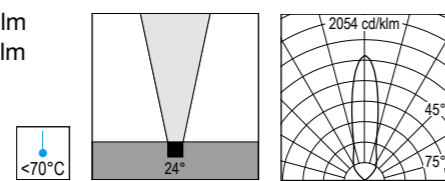

<70°C

5323.CGF.T.15 26 W 1 Led 3000 K 2689 lm
5323.CHF.T.15 26 W 1 Led 4000 K 2810 lm
220-240 V 50/60 HZ
vetro trasparente *clear diffuser*
alimentatore incluso
led driver integral

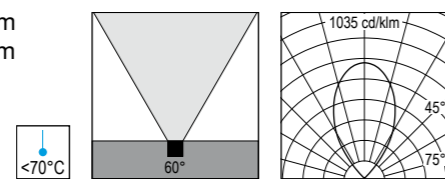

<70°C

H (m)	Ø (m)	lux med. 3000 K	lux max. 3000 K	lux med. 4000 K	lux max. 4000 K
5	2.11	104	221	108	231
4	1.69	162	345	169	361
3	1.26	288	614	301	641
2	0.84	648	1380	677	1443
1	0.42	2591	5522	2708	5770

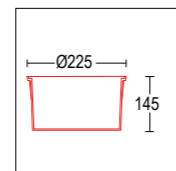
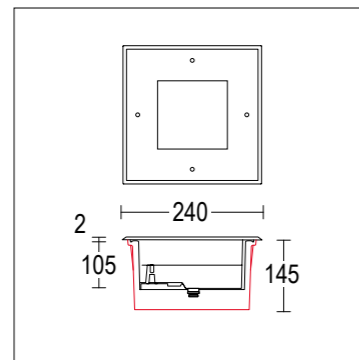
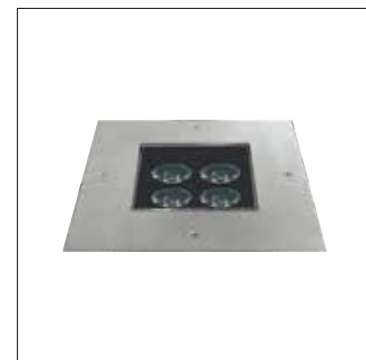

codice controcassa
rough-in housing code
017

codice colori
colour codes
.15 acciaio inox
stainless steel

5323.FAP.T.15 15 W 4 Led 3000 K 2132 lm
5323.FBP.T.15 15 W 4 Led 4000 K 2356 lm
220-240 V 50/60 HZ
vetro trasparente *clear diffuser*
alimentatore incluso *led driver integral*
orientabile *adjustable* 10°

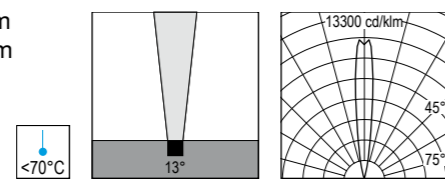

<70°C

H (m)	Ø (m)	lux med. 3000 K	lux max. 3000 K	lux med. 4000 K	lux max. 4000 K
5	1.16	581	1134	643	1253
4	0.93	909	1772	1004	1958
3	0.69	1615	3151	1785	3482
2	0.46	3634	7089	4016	7834
1	0.23	14536	28356	16063	31335

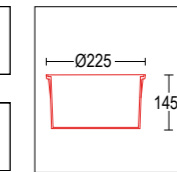
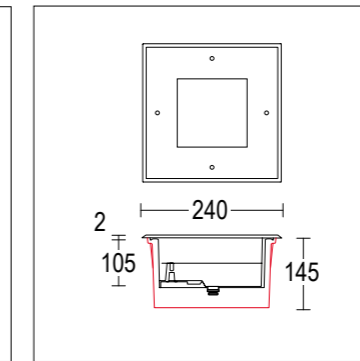
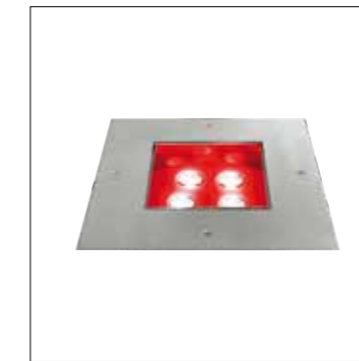

codice controcassa
rough-in housing code
017

codice colori
colour codes
.15 acciaio inox
stainless steel

5323.P3E.T.15 12 W 4 Led RGB 420 lm
max 350 mA DC
vetro trasparente *clear diffuser*
alimentatore remoto SELV non incluso
remote SELV led driver not included
orientabile *adjustable* 10°

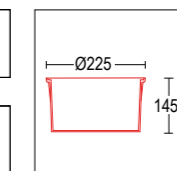
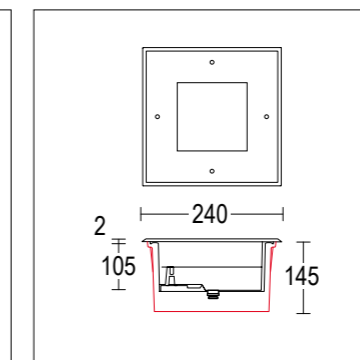
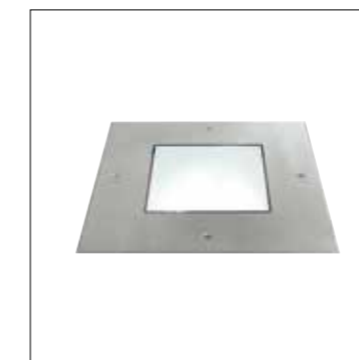
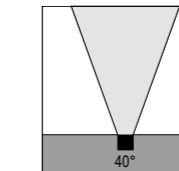

codice controcassa
rough-in housing code
017

codice colori
colour codes
.15 acciaio inox
stainless steel

5323.36F.A.15 57 W INC E27
220-240 V 50/60 HZ
vetro acidato *acid etched diffuser*

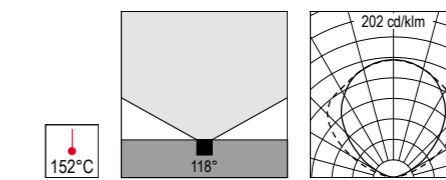

152°C

H (m)	Ø (m)	lux med.	lux max.
5	16.71	1	15
4	13.37	2	23
3	10.03	3	40
2	6.68	6	91
1	3.34	25	364

5323.80F.A.15 26W TC-T Gx24d-3 1800 lm
220-240 V 50/60 HZ
vetro acidato *acid etched diffuser*
alimentatore ferromagnetico incluso
conventional ballast integral

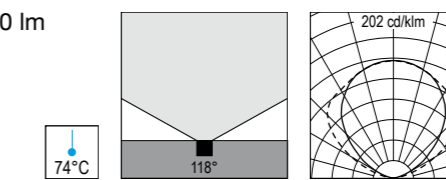

74°C

H (m)	Ø (m)	lux med.	lux max.
5	16.71	1	15
4	13.37	2	23
3	10.03	3	40
2	6.68	6	91
1	3.34	25	364

5323.92F.A.15 26W TC-T Gx24q-3 1800 lm
220-240 V 50/60 HZ
vetro acidato *acid etched diffuser*
alimentatore elettronico incluso
electronic ballast integral

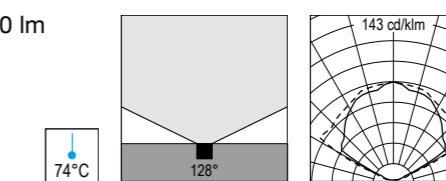

74°C

H (m)	Ø (m)	lux med.	lux max.
5	21.74	4	71
4	17.39	6	111
3	13.04	10	197
2	8.70	23	443
1	4.35	94	1773

Accessori Spiacar

Spiacar accessories

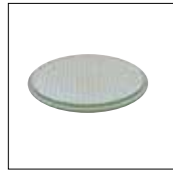

105
Vetro anti-scivolo
fattore R12 DIN 51130
anti-slip glass
factor R12 DIN 51130

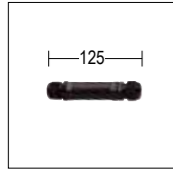

276
Connettore rapido IP 68
IP 68 fast connector

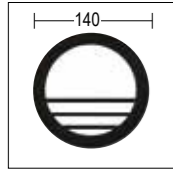

158
Schermo anti-abbagliamento
Solo per la versione 1 Led simmetrica
Vouvre screen anti glare
only for 1 Led symmetrical version

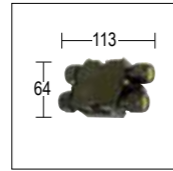

279
Connettore per cablaggio in cascata IP 68
IP 68 connector for through wiring

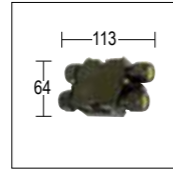

278
Connettore per cablaggio in cascata RGB IP 68
IP 68 RGB connector for through wiring

Accessori RGB

RGB accessories



627
Alimentatore 350 mA
1 alimentatore per 1-2 Spiacar RGB
Led driver 350 mA
1 local power source for 1-2 Spiacar RGB

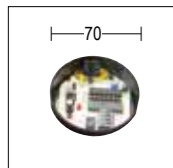

628
Convertitore
1 convertitore per 10 alimentatori 627
Converter
1 Converter for 10 led drivers 627

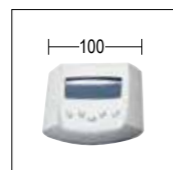

626
Generatore DMX
1 generatore per 6 convertitori
DMX generator
1 generator for 6 converters

Schema di collegamento RGB
RGB scheme

