

IP65 codice colori
colour codes

.05 grigio antracite
anthracite grey

.13 grigio chiaro
light grey

IK09

5564.CDS.T.-- 39 W 1 Led 3000 K 3765 lm
5564.CES.T.-- 39 W 1 Led 4000 K 3932 lm
 220-240 V 50/60 HZ
 vetro trasparente *clear diffuser*
 alimentatore incluso *led driver integral*

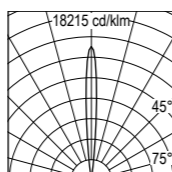
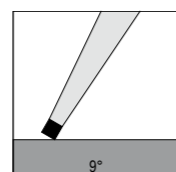

H (m)	Ø (m)	lux med. 3000 K	lux max. 3000 K	lux med. 4000 K	lux max. 4000 K
5	0.77	1392	2743	1453	2865
4	0.62	2174	4286	2271	4476
3	0.46	3866	7620	4037	7958
2	0.31	8698	17145	9083	17906
1	0.15	34791	68580	36334	71622

5564.CDF.T.-- 39 W 1 Led 3000 K 3765 lm
5564.CEF.T.-- 39 W 1 Led 4000 K 3932 lm
 220-240 V 50/60 HZ
 vetro trasparente *clear diffuser*
 alimentatore incluso *led driver integral*

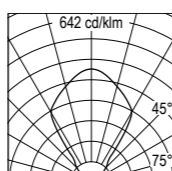
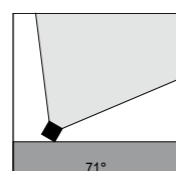

H (m)	Ø (m)	lux med. 3000 K	lux max. 3000 K	lux med. 4000 K	lux max. 4000 K
5	7.13	26	97	27	101
4	5.71	41	151	43	158
3	4.28	73	269	76	281
2	2.85	164	605	172	631
1	1.43	658	2418	687	2526

5564.17S.T.-- 35 W HIT G12 3300 lm
 230 V 50 HZ
 vetro trasparente *clear diffuser*
 alimentatore ferromagnetico incluso
conventional ballast integral

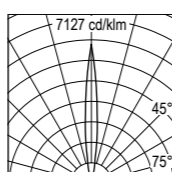
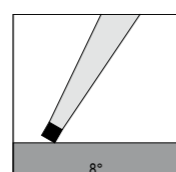

H (m)	Ø (m)	lux med.	lux max.
5	0.84	475	941
4	0.67	742	1470
3	0.50	1319	2613
2	0.34	2968	5880
1	0.17	11870	23520

5564.17M.T.-- 35 W HIT G12 3300 lm
 230 V 50 HZ
 vetro trasparente *clear diffuser*
 alimentatore ferromagnetico incluso
conventional ballast integral

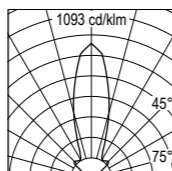
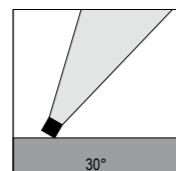

H (m)	Ø (m)	lux med.	lux max.
5	2.75	65	144
4	2.20	102	225
3	1.65	181	401
2	1.10	406	901
1	0.55	1626	3606

5564.19S.T.-- 70 W HIT G12 6600 lm
 230 V 50 HZ
 vetro trasparente *clear diffuser*
 alimentatore ferromagnetico incluso
conventional ballast integral

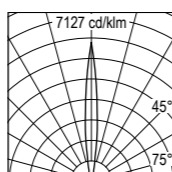
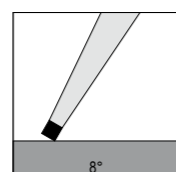

H (m)	Ø (m)	lux med.	lux max.
5	0.84	950	1882
4	0.67	1484	2940
3	0.50	2638	5227
2	0.34	5935	11760
1	0.17	23740	47041

5564.19M.T.-- 70 W HIT G12 6600 lm
 230 V 50 HZ
 vetro trasparente *clear diffuser*
 alimentatore ferromagnetico incluso
conventional ballast integral

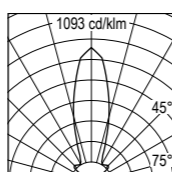
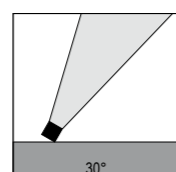

H (m)	Ø (m)	lux med.	lux max.
5	2.75	130	288
4	2.20	203	451
3	1.65	361	801
2	1.10	813	1803
1	0.55	3251	7211

5564.21S.T.-- 150 W HIT G12 14000 lm
 230 V 50 HZ
 vetro trasparente *clear diffuser*
 alimentatore ferromagnetico incluso
conventional ballast integral

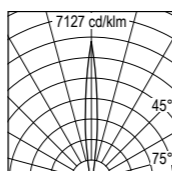
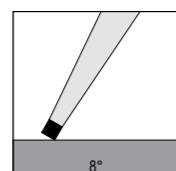

H (m)	Ø (m)	lux med.	lux max.
5	0.84	2014	3991
4	0.67	3147	6236
3	0.50	5595	11087
2	0.34	12590	24946
1	0.17	50359	99784

5564.21M.T.-- 150 W HIT G12 14000 lm
 230 V 50 HZ
 vetro trasparente *clear diffuser*
 alimentatore ferromagnetico incluso
conventional ballast integral

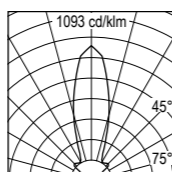
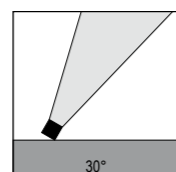

H (m)	Ø (m)	lux med.	lux max.
5	2.75	276	612
4	2.20	431	956
3	1.65	766	1700
2	1.10	1724	3824
1	0.55	6896	15296



photo: Germano Borrelli

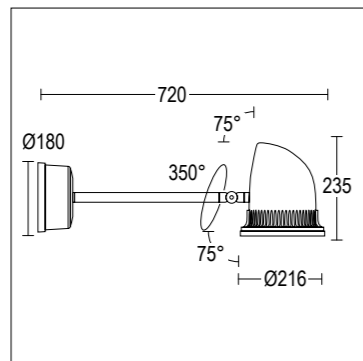

IP65
IK09

codice colori
colour codes

.05 grigio antracite
anthracite grey

.13 grigio chiaro
light grey

5568.CDS.T.-- 39 W 1 Led 3000 K 3765 lm
5568.CES.T.-- 39 W 1 Led 4000 K 3932 lm
220-240 V 50/60 HZ
vetro trasparente *clear diffuser*
alimentatore incluso *led driver integral*

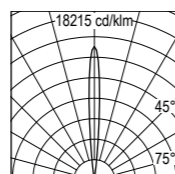
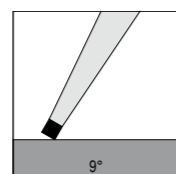

H (m)	Ø (m)	lux med. 3000 K	lux max. 3000 K	lux med. 4000 K	lux max. 4000 K
5	0.77	1392	2743	1453	2865
4	0.62	2174	4286	2271	4476
3	0.46	3866	7620	4037	7958
2	0.31	8698	17145	9083	17906
1	0.15	34791	68580	36334	71622

5568.CDF.T.-- 39 W 1 Led 3000 K 3765 lm
5568.CEF.T.-- 39 W 1 Led 4000 K 3932 lm
220-240 V 50/60 HZ
vetro trasparente *clear diffuser*
alimentatore incluso *led driver integral*

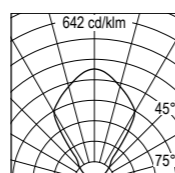
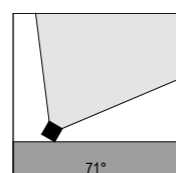

H (m)	Ø (m)	lux med. 3000 K	lux max. 3000 K	lux med. 4000 K	lux max. 4000 K
5	7.13	26	97	27	101
4	5.71	41	151	43	158
3	4.28	73	269	76	281
2	2.85	164	605	172	631
1	1.43	658	2418	687	2526

5568.17S.T.-- 35 W HIT G12 3300 lm
230 V 50 HZ
vetro trasparente *clear diffuser*
alimentatore ferromagnetico incluso
conventional ballast integral

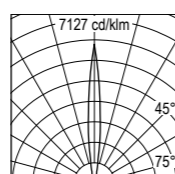
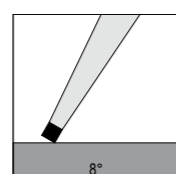

H (m)	Ø (m)	lux med.	lux max.
5	0.84	475	941
4	0.67	742	1470
3	0.50	1319	2613
2	0.34	2968	5880
1	0.17	11870	23520

5568.17M.T.-- 35 W HIT G12 3300 lm
230 V 50 HZ
vetro trasparente *clear diffuser*
alimentatore ferromagnetico incluso
conventional ballast integral

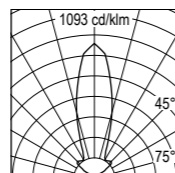
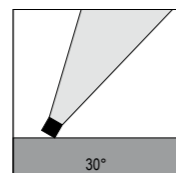

H (m)	Ø (m)	lux med.	lux max.
5	2.75	65	144
4	2.20	102	225
3	1.65	181	401
2	1.10	406	901
1	0.55	1626	3606

5568.19S.T.-- 70 W HIT G12 6600 lm
230 V 50 HZ
vetro trasparente *clear diffuser*
alimentatore ferromagnetico incluso
conventional ballast integral

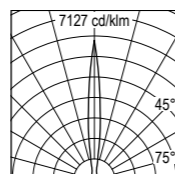
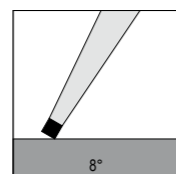

H (m)	Ø (m)	lux med.	lux max.
5	0.84	950	1882
4	0.67	1484	2940
3	0.50	2638	5227
2	0.34	5935	11760
1	0.17	23740	47041

5568.19M.T.-- 70 W HIT G12 6600 lm
230 V 50 HZ
vetro trasparente *clear diffuser*
alimentatore ferromagnetico incluso
conventional ballast integral

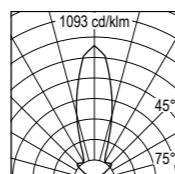
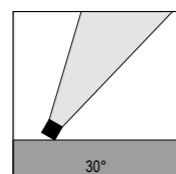

H (m)	Ø (m)	lux med.	lux max.
5	2.75	130	288
4	2.20	203	451
3	1.65	361	801
2	1.10	813	1803
1	0.55	3251	7211

5568.21S.T.-- 150 W HIT G12 14000 lm
230 V 50 HZ
vetro trasparente *clear diffuser*
alimentatore ferromagnetico incluso
conventional ballast integral

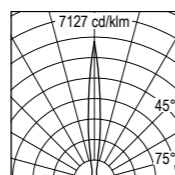
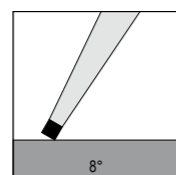

H (m)	Ø (m)	lux med.	lux max.
5	0.84	2014	3991
4	0.67	3147	6236
3	0.50	5595	11087
2	0.34	12590	24946
1	0.17	50359	99784

5568.21M.T.-- 150 W HIT G12 14000 lm
230 V 50 HZ
vetro trasparente *clear diffuser*
alimentatore ferromagnetico incluso
conventional ballast integral

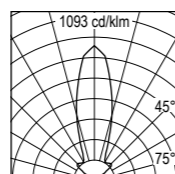
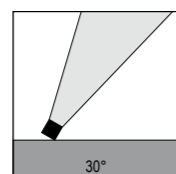

H (m)	Ø (m)	lux med.	lux max.
5	2.75	276	612
4	2.20	431	956
3	1.65	766	1700
2	1.10	1724	3824
1	0.55	6896	15296



Accessori Vik Vik accessories



714 grigio antracite *anthracite grey*
715 grigio chiaro *light grey*
Visiera in alluminio *aluminium hood*
da installare sotto l'anello
to be installed under the standing ring

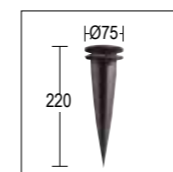

711
Picchetto nero in nylon
Black nylon stake



533
Schermo anti-abbagliamento
Solo per la versione HIT G12
Vouvre screen anti glare
only for HIT G12 version



230
Cintura di sostegno
Support belt